

ACE **APEX**TM

User Manual



MULTI-FLEXTM
MULTI-FREQUENCY TECHNOLOGY

ELEVATE YOUR DETECTING TO THE NEXT LEVEL



6" x 11" DD Coil
VIPERTM
MULTI-FLEXTM
SERIES COIL

GARRETT[®]
METAL DETECTORS

Contents

Quick Start Steps.....	3	Notch Discrimination	16
Contents.....	4	Auto Ground Balance.....	17
Assembly.....	5	Iron Audio	18
Assembled Detector.....	6	Detecting Tips and Techniques	19
Battery Information	7	Pinpointing.....	21
Basic Controls.....	8	Bench Tests	22
LCD/Display Elements.....	9	General Advice.....	23
Target ID Information.....	10	Troubleshooting.....	24
Digital Target ID.....	10	Warranty.....	25
Audio Target ID.....	10	Technical Specs.....	26
Z-Lynk Wireless Operation	11		
Menu Settings	12		
Adjusting Sensitivity.....	12		
Volume and Iron Volume Settings.....	12		
Changing Frequency / Channels.....	12		
Backlight Control.....	12		
Wireless Headphone Control.....	12		
Multi-Frequency Options	13		
Search Modes	14		
Zero Discrimination	14		
Coins.....	14		
US Coins	14		
Jewelry	14		
Relics	14		
Custom	14		



Quick Start Steps

1. Power ON.

Press and release the ON / OFF Power button. The Apex powers on in the last mode used and is ready to search. The detector operates on built-in lithium ion rechargeable batteries.



2. Select Mode.

Use the Mode button to select a different detection mode, when desired.

3. Adjust settings.

Press Menu Button to adjust Sensitivity, Volume, Iron Volume, Frequency, Channel, Backlight, or Z-Lynk settings, if desired.

4. Ground Balance (if necessary).

Press and hold GND BAL button while bouncing coil above the ground.

5. Begin scanning.

Lower the searchcoil to about one inch (2.5cm) above the ground and scan the coil left and right at approximately 3 feet/second (1 meter/second). The coil must be in motion for target detection, but can remain stationary during Pinpoint.

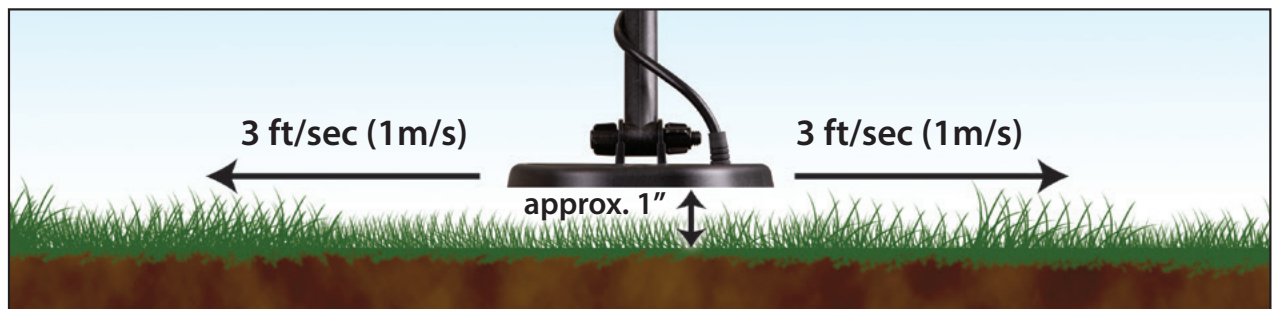

Apex Carton Contents

The ACE Apex is packaged with the following parts, some partially assembled. If any part is missing, please contact Garrett Customer Service.

Armrest with armrest strap



S-shaped stem assembly with mounted control box

6" x 11" DD Viper Searchcoil with coil cover installed



Upper and lower stem (connected)



Micro-USB charging cable



Quick-Start Guide

Note: ACE Apex user's manual is available on garrett.com in multiple languages



Nut, bolt, mounting washers



Included with PN 1142325 Z-Lynk Wireless Headphone Package

MS-3 Wireless headphones and USB charging cable

Note: MS-3 wireless headphones are not included with PN 1142320



Assembly

Extend shaft and insert washers

1. Loosen upper camlock by turning it right (clockwise) while holding the upper and lower stem assembly in front of you.
2. Extend lower stem.
3. Press mounting washers into place.

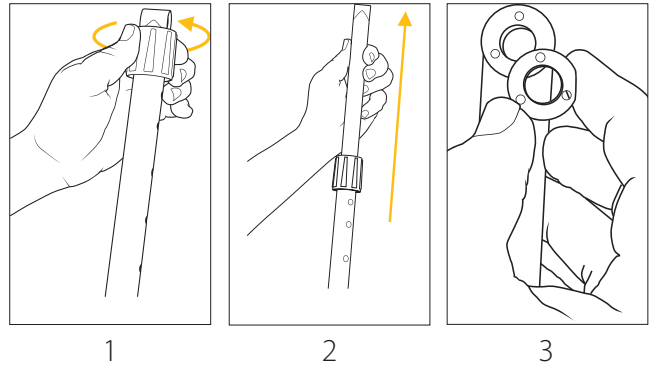

Attach the searchcoil

1. Insert the lower stem assembly into the searchcoil bracket.
2. Insert bolt and hand-tighten wing nut.

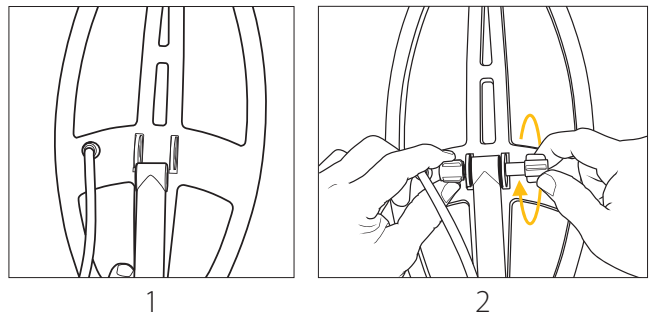

Attach the S-stem to lower shaft

1. Loosen upper camlock and insert S-stem with control housing.
2. Adjust lower stem to comfortable length, and hand-tighten the camlocks.
3. Wrap cable snugly around the stem with the first turn of the cable over the stem.
4. Insert coil connector into back of control box, making sure to properly line up 5-pin connector.

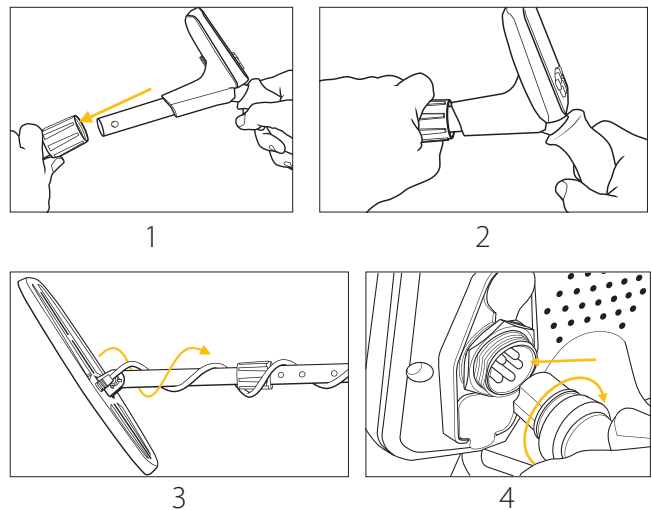

Adjusting arm cuff (if desired)

1. Remove the screw on the bottom.
2. Move the 2-piece cuff to the other position.
3. Reinsert screw and tighten.

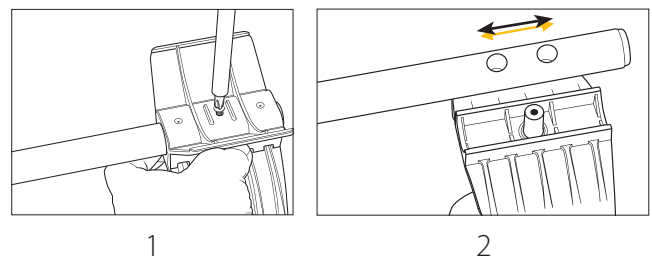

Assembled Detector

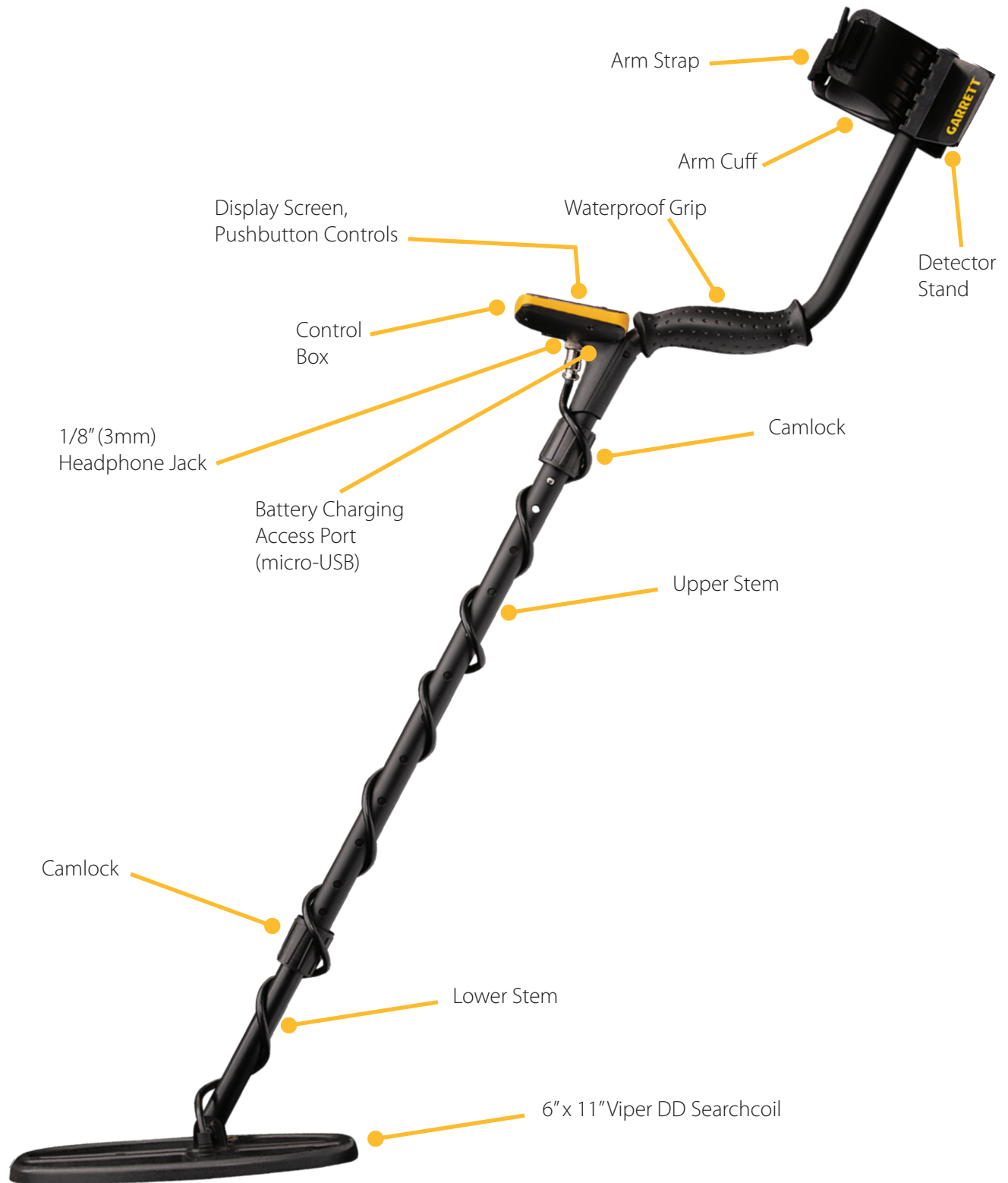

Battery Information

Basic Information

Battery Type:	Internal Lithium-Ion
Battery Life:	15 hrs typical, depending on settings
Battery Scale:	25% per pixel, bottom pixel flashes at 5% remaining
Recharge Time:	4 hours from any USB port (with detector OFF, longer if ON).
Charging Status:	Flashing while charging, solid when charged
Battery Life Cycle:	Batteries will last for many years. Recharge at least once a year
Charging Note:	Detector should be switched off during charging to speed the charging process.

Detecting with a Power Bank

In the event of a depleted battery in the field, *Apex* can be operated while plugged into any external 5V USB power pack via USB cable. Recommend attaching power pack to armrest.

Note on Battery Life

To extend the life of your detector's internal battery, it should be charged prior to storage for extended periods and recharged at least once per year. It is not necessary to fully discharge the *Apex* battery prior to charging.

Ultimately the cost of ownership is lower than replaceable batteries and have an added benefit of lower environmental impact. In the event of premature failure, the battery can be replaced at any certified Garrett service center.

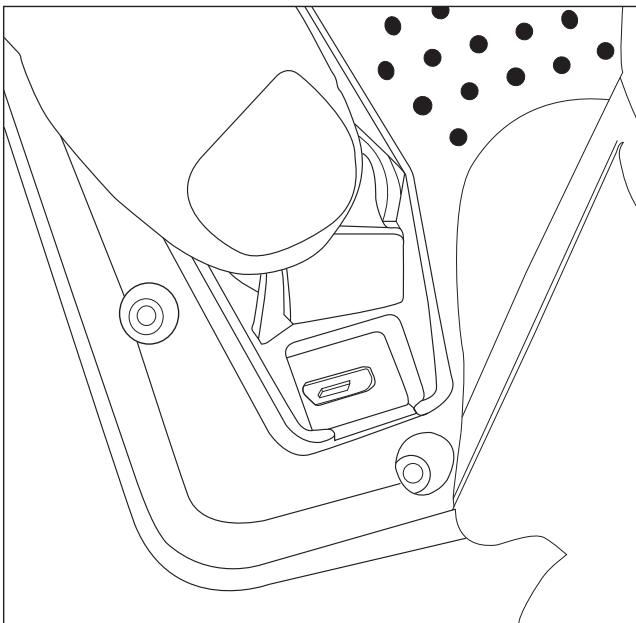

Micro-USB charging port is located under a weather-proof rubber flap on back of *Apex* control box.

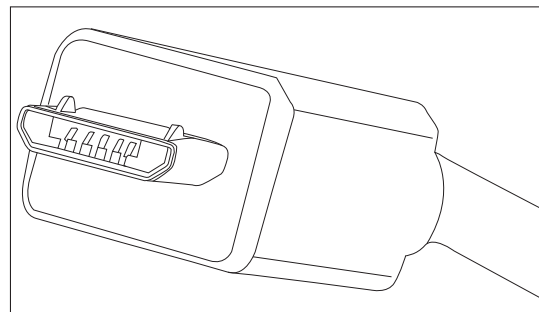

Note orientation of micro-USB connector before plugging into back of *Apex* control box.

Basic Controls



- 1. Power ON/OFF and MODE**—Hold this button for 1 second to turn power ON or OFF. Once detector is on, use the Mode button to select a different detection mode, when desired. Press and hold this button for five seconds to restore detector to Factory Settings.
- 2. Plus/Minus and NOTCH DISC.** Use Plus/Minus to change settings while using MENU button controls and to move cursor when changing Notch Discrimination.
- 3. Ground Balance/HOLD**—Hold this button down while ground balancing the detector.
- 4. Iron Audio**—Allows the user to hear discriminated iron (normally silenced) in order to avoid digging tricky, undesired flat iron items such as bottle caps or steel washers.
- 5. MENU**—Press to scroll through Menu settings by continuing to tap this button. Allows access to Sensitivity, Volume, Iron Volume, Frequency options, Channel options, Backlight, and Z-Lynk Wireless pairing.
- 6. Pinpoint/OPERATE**—Hold this button for pinpointing function, which enables fast recovery with the smallest hole possible. Press and release OPERATE button to exit Menu settings.
- 7. Accept/Reject**—Accepts or Rejects targets by switching on/off individual Discrimination Segments from the Target ID Legend. Use in conjunction with the Plus/Minus buttons to move the cursor above any desired Notch Discrimination pixel (see item 2).



LCD/Display Elements

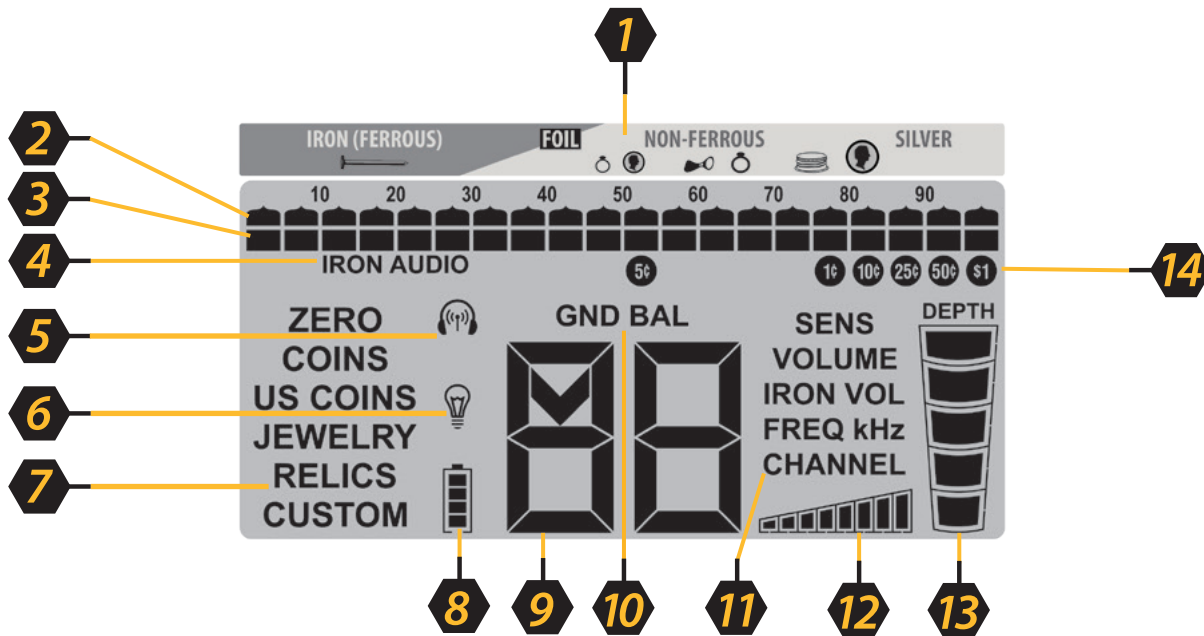

- 1. Target ID Legend**—indicates different metal types (from ferrous to non-ferrous targets).
- 2. Target ID Cursor**—Indicates Target ID of detected target. Audio is only produced for accepted targets.
- 3. Discrimination Pattern**—Lighted pixel indicates accepted targets, blank pixel indicates rejected targets.
- 4. Iron Audio**—Indicates Iron Audio feature is in use when displayed.
- 5. Wireless headphones**—Wireless icon flashes while attempting to pair. Wireless icon is solid when unit is paired with headphones.
- 6. Backlight**—Indicates LCD Back Light feature is in use when displayed.
- 7. Search Mode**—Displays the in-use Search Mode (i.e. US Coins, Jewelry, Relics, etc.). The mode that is currently selected will be indicated.
- 8. Battery Level**—Shows continuous status of battery life. Re-charge battery when 1 segment remains.
- 9. Digital Target ID**—Provides a value from 0 to 99 to identify targets more precisely than the ID cursor. Also indicates modes and adjustment levels when altering settings.
- 10. Ground Balance**—When shown, this indicates detector is in Ground Balance mode.
- 11. Menu Control Options**—Tap Menu button to scroll through detector setting options: Sensitivity, Volume, Iron Volume, Frequency, Channel, Backlight, and Wireless Headphones.
- 12. Sensitivity**—Indicates current Sensitivity setting.
- 13. Target Depth**—Shows the depth of a coin, or a similar sized target. Note: targets larger than a coin may display shallower than actual depth while targets smaller than a coin may display deeper than actual depth.
- 14. U.S. Coin Icons**—Indicates possible identity of U.S. coin targets. These icons are only displayed when detector is operating in U.S. Coins Mode.

Target ID Information

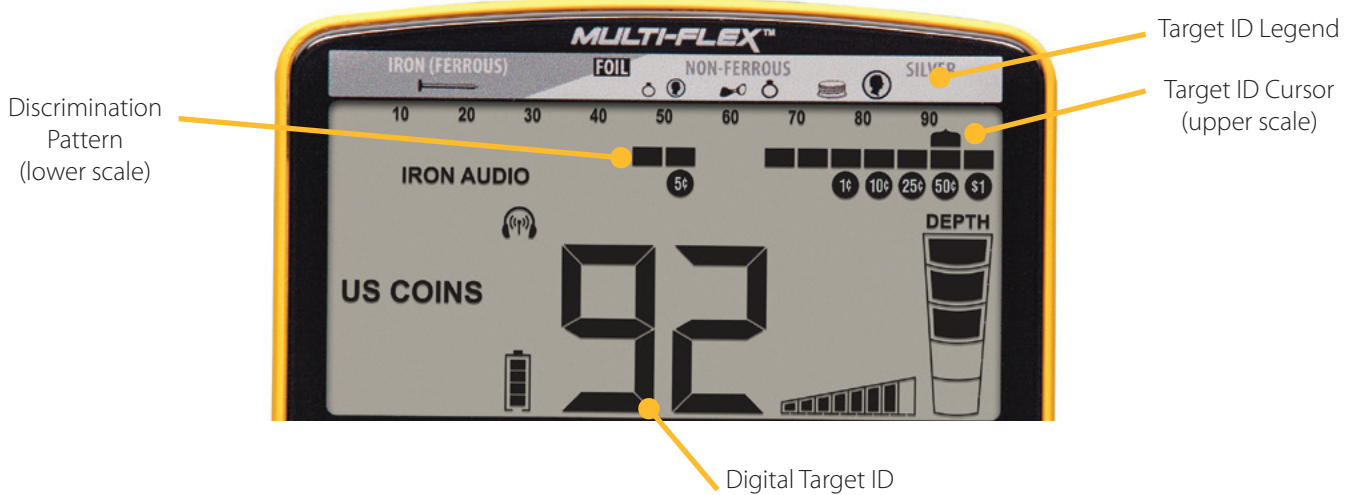

Digital Target ID

The large Digital Target ID number in the lower center of the LCD provides a value from 0 to 99 to identify targets more precisely than the ID Cursor. The Target ID Legend at top works with the Target ID cursor to indicate a target's probable identity, with ferrous (iron) targets at the left, non-ferrous targets that are thin or have low conductivity in the middle, and thick or high conductivity targets (e.g. thick silver) at the right.

Target ID can vary widely based upon the target's size and thickness because small, thin pieces of metal cannot conduct electrical current as well as thicker pieces of metal. In addition, mineralized soils can cause Target ID errors, especially for small targets.

Tip: Target ID is most reliable when the target is centered under the searchcoil and the coil is swept flat and at a constant height above the ground.

Audio Target ID

Ferrous targets (Digital ID < 35) such as nails, iron, steel, etc.

Ferrous and very low conductivity targets

Low conductivity targets like nickels and small jewelry

Non-ferrous targets, including large jewelry and coins such as U.S. pennies

Non-ferrous targets of high conductivity (Digital ID >79), including larger silver coins

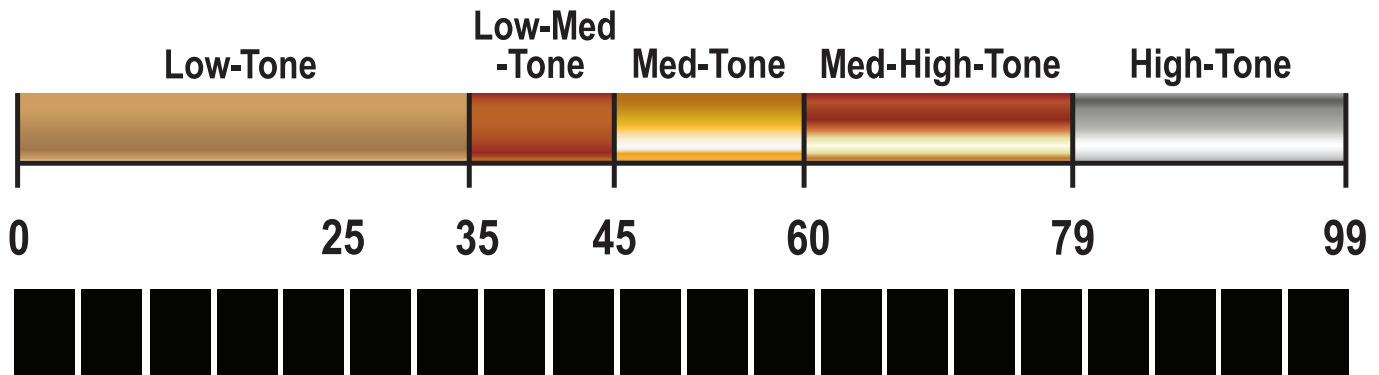

Z-Lynk Wireless Operation

Apex features a built-in Z-Lynk wireless transmitter which can be used with Garrett MS-3 wireless headphones and any Z-Lynk enabled devices (such as any other headphones connected to a Z-Lynk receiver).

A Z-Lynk Wireless headphone icon (see illustration) on the LCD indicates the current status of your wireless connection. A steady icon indicates the detector is paired with an operating Z-Lynk receiver that is within range. A flashing icon indicates that the detector is searching for a receiver. Absence of the icon indicates that *Apex's* wireless transmitter is switched off.

Pairing: To pair with a new set of headphones/receiver, simply switch the headphone/receiver on, hold within 2 feet (0.6 meters) of the *Apex*. Next, power on *Apex*, press the MENU button, and continue tapping the MENU button until the wireless icon is highlighted (as indicated in this illustration). Press the (+) button to pair the headphones.

Once paired, if the headphone/receiver is switched off or moved out of range, *Apex* will search and attempt to reconnect to the receiver for 5 minutes, indicated by a flashing icon. If the connection is not reestablished during this time, *Apex* will switch off its wireless transmitter. To reconnect, simply switch the *Apex* off and then on again.

To un-pair (forget) a set of headphones, simply press the press the MENU button to select the wireless icon and then use the (-) button to un-pair.

Use of optional wired headphones: *Apex* can also be operated with any wired headphones that have a 1/8" plug. For headphones with a 1/4" plug, an optional adaptor is available from Garrett.



Note: Packages shipped with MS-3 headphones include a user's guide for full details on wireless headphone operation.

Menu Settings

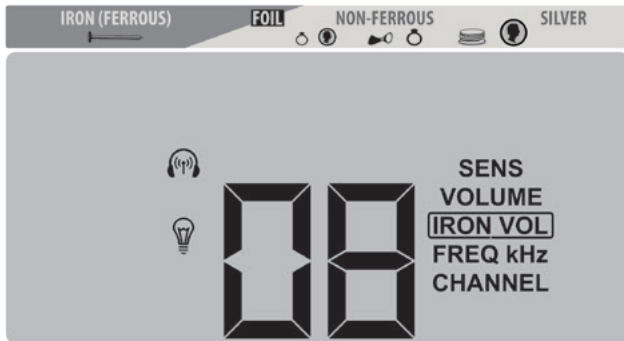

Adjusting Menu Settings

Press the MENU button and then continue tapping the MENU button to scroll through seven options: Sensitivity, Volume, Iron Volume, Frequency, Channel, Backlight, and Wireless Headphones. Each Menu item can be adjusted with use of the (+) or (-) buttons.

Sensitivity

Eight (8) levels. Use increased sensitivity when searching for very small or very deep targets. Use lower sensitivity levels when the detector is behaving erratically (due to excessive metallic trash, highly mineralized soils, electrical interference or the presence of other metal detectors) and the erratic operation cannot be resolved with ground balance, discrimination or by changing frequency.

Volume

Eight (8) levels. This is an overall volume control for both the built-in speaker and headphones.

Iron Volume

Eight (8) levels. Iron Volume allows you to decrease the volume of ferrous targets, while the volume of non-ferrous targets remains at normal level. Experienced treasure hunters, who often like hearing all targets, have the advantage with Iron Volume to decrease the volume of undesired items.

Frequency Options

Six (6) FREQ kHz settings on Apex: 5 kHz, 10 kHz, 15 kHz, 20 kHz, Multi-Frequency (MF) mode, and Multi-Frequency Salt (MS) mode. (See page 13 for complete information on Multi-Flex multi-frequency technology and details on each frequency option.)

Channel

Eight (8) channels, or independent frequency shifts, for each single and multi-frequency. With 48 different frequency adjustments, Apex has an increased ability to hunt alongside other detectors at crowded field events and to overcome other electrical interference.

Backlight



Use the (+) or (-) buttons to switch on or off the LCD backlight, for searching at night or in low-light areas.

Wireless Headphones



Use the (+) or (-) buttons to switch on or off the built-in Z-Lynk wireless operation. Press (+) to pair Z-Lynk enabled wireless headphones and press (-) to unpair headphones. Note: Switch on the Z-Lynk enabled headphones first, and then press (+) button when Wireless Headphones option is highlighted within the Menu settings.



Multi-Flex™ Multi-Frequency Options

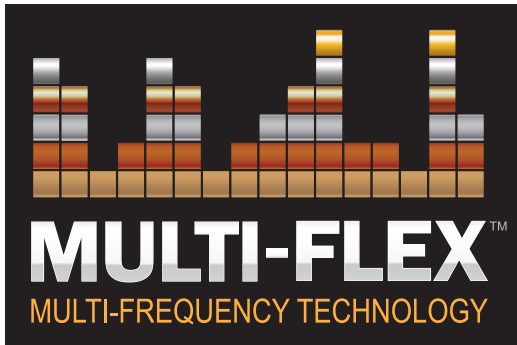

Garrett's Multi-Flex Multi-Frequency technology, fueled by a cutting edge, broad-bandwidth digital platform, offers you complete detecting flexibility. Each of the 6 frequency options is available while operating in any Apex search mode (i.e., Jewelry, Relics, Coins, etc.).

Choose from powerful single frequencies where all of the detector's transmitter power is focused into one frequency to offer enhanced detection on certain types of targets. Or select one of Apex's simultaneous multi-frequency modes to achieve excellent detection on all targets in all soils.

5 kHz | **10 kHz** | **15 kHz** | **20 kHz**

Single Frequency Operation

Apex offers 4 single frequencies of 5 kHz, 10 kHz, 15 kHz, and 20 kHz. In certain detecting situations, using a single frequency may offer a slight advantage over use of one of Apex's multi-frequency modes.

For example, using 20 kHz to search for small gold nuggets or hammered silver coins may offer enhanced detection. Selecting 5 kHz to search for larger, high conductive targets such as large silver coins might be another advantage.

Single frequency operation may offer quieter operation than multi-frequency in some noisy environments with high electromagnetic interference.

Multi-Frequency | Multi-Salt

Multi-Frequency Operation

In addition to powerful single frequencies, Apex offers two multi-frequency operating platforms. Each multi-frequency option is a combination of multiple frequencies being transmitted, received and processed simultaneously.

The standard **Multi-Frequency Mode** (labeled as MF on its menu) employs a blend of frequencies that provide maximum target detection on all types and sizes of targets, while also minimizing ground noise. Intended for land use hunting.

Apex's **Multi-Frequency Salt Mode** (labeled as MS on its menu) utilizes a blend of frequencies to help overcome the negative effects of saltwater beaches.

As you move from the dry sand into the wet sand and into the shallow water, increasing levels of salt minerals may cause your detector to become unstable. Switch to Multi-Frequency Salt Mode to achieve maximum stability and target detection. Ground balance your detector if needed.

In saltwater areas with more highly mineralized sands, you may choose to reduce Sensitivity to achieve maximum stability.

Search Modes

The Garrett *Apex* includes six search modes, based on desired targets (i.e. coins, jewelry). Choose the mode that is best for your particular detecting needs, or select Custom Mode to create and save your own favorite detector settings.

You can further refine your detecting experience by selecting from six different frequency settings within each of the optional modes. Simply tap the Mode button to scroll through the Mode options.

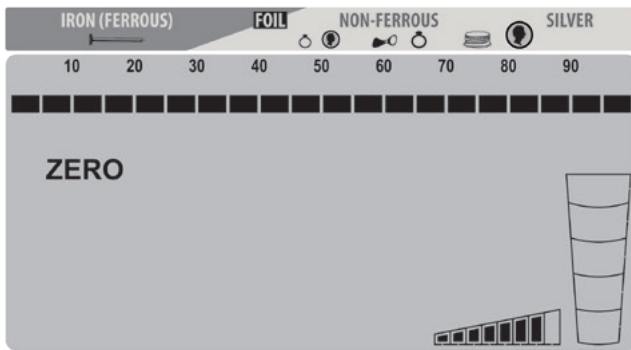

ZERO Discrimination Mode

Detects every type of metal. All 20 discrimination pixels are switched on; no metals targets have been notched out (eliminated). Use this mode to find all metal items or when the material of the desired object is unknown. Switch to Zero Disc Mode to aid in locating a target when its signal is inconsistent. Such signals could mean a trash target is close to a good target.

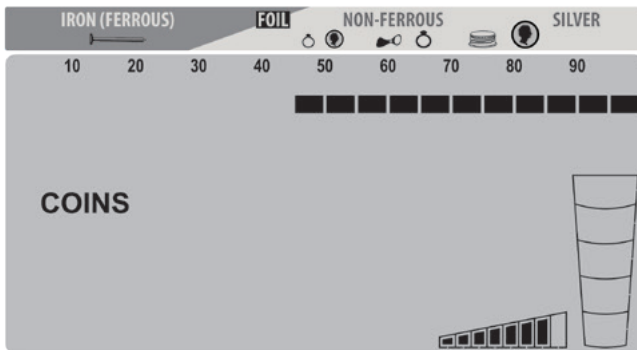

COINS Mode

Designed to find all types of international coins, ranging from small bronze and hammered coins all the way

to large silver medallions. Pixels for iron and foil have been eliminated from detection.

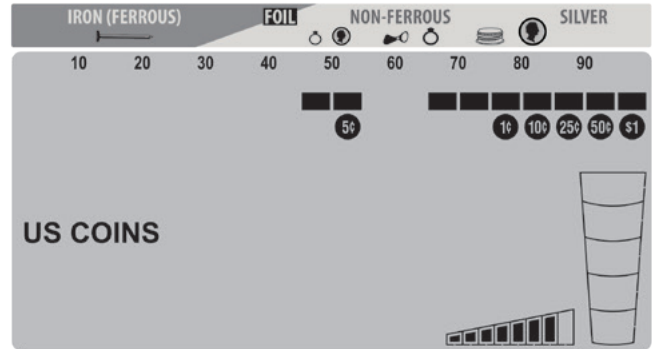

US COINS Mode

Designed to find U.S. and similar coins, and to eliminate common trash items such as iron, foil, and pull-tabs. Be aware that medium-sized jewelry may be missed with this discrimination pattern. Some digging of junk targets should be expected, such as aluminum cans. Note that icons for common U.S. coins appear on the LCD below the notch discrimination pixels.

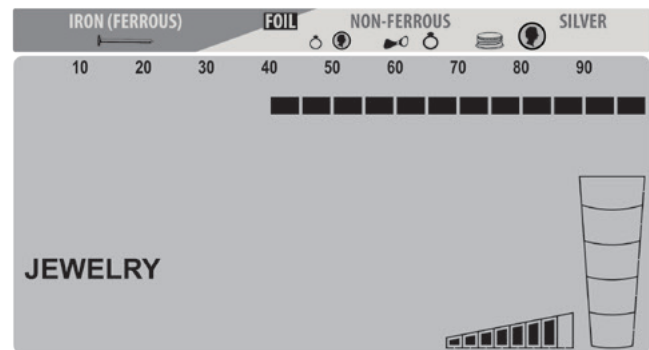

JEWELRY Mode

Designed to find jewelry like rings, bracelets, watches, and necklaces, while ignoring most iron trash.



Search Modes *(continued)*

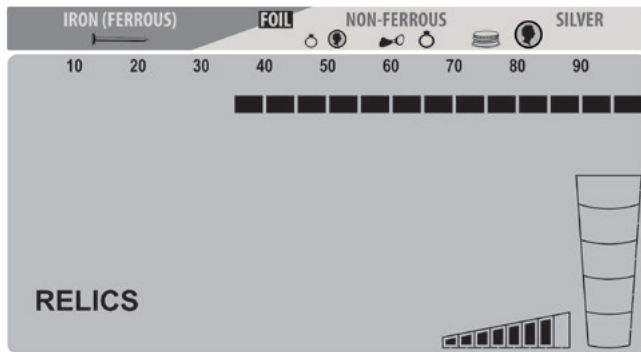

RELICS Mode

Designed to eliminate small iron pieces, while detecting good targets in the lower conductivity range, such as lead, brass and bronze.

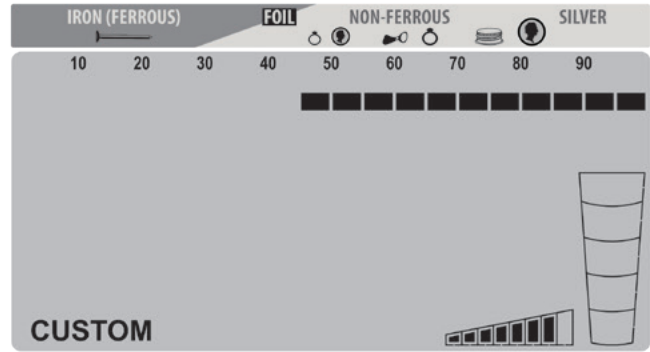

CUSTOM Mode

Can be programmed by the operator and the *Apex* will retain the changes when the detector is switched off. The factory preset for CUSTOM Mode is the same as the COINS Mode. Begin with this discrimination pattern and then use the (+) and (-) NOTCH DISC buttons to move the cursor. Once the cursor is above the desired notch discrim pixel, use the Accept/Reject buttons controls to customize the mode.

Notch Discrimination

Apex has 20 pixels or “notches” of discrimination, shown on the lower scale. Any combination of these pixels can be switched on or off based upon your preference. There are two primary methods for modifying the Notch Discrimination Pattern to reject a specific type of trash or unwanted item.

For the first method, use the (+) or (-) NOTCH DISC buttons to move the Target ID cursor to the left or right. Next, press the (✓/x) elim button to eliminate or activate the pixel located on the Lower Scale, directly below the Target ID cursor. (See illustrations on next page.)

The second method of modifying the Notch Discrimination pattern uses only the (✓/x) elim button. When an unwanted target is audibly detected, simply push the (✓/x) elim button to create a notch at that Target ID Cursor. The next time this item is encountered, it will not produce an audible signal.

Tip: Notch Discrimination can also be used to find specific metal items. For example, if an earring has been lost, scan the matching earring in ZERO-DISC mode and note its Target ID cursor. Then, use the NOTCH DISC and (✓/x) elim buttons to switch off all the pixels except the one for the earring and an additional pixel on either side to account for some ID variations.

Example of Manual Modification to Notch Discrimination Pattern



Modify pattern with these buttons



Use the NOTCH DISC buttons to position the Target ID Cursor above the pixel you wish to eliminate (see illustration to left). Use the (✓/x) elim button to delete this pixel from the Lower Scale (see below). This item is now rejected.

Note: Changes made to the Notch Discrimination pattern while in CUSTOM Mode will be retained when the detector is switched OFF. Changes made to all other modes will return to the factory settings when the detector is switched OFF and back ON.



Auto Ground Balance

Detector performance can be negatively affected by ground mineralization. Apex can be ground balanced automatically to cancel unwanted ground signals and obtain maximum stability and target detection.

Note: Always locate an area of soil free of metal before attempting to ground balance the detector. Apex includes High Resolution Ground Balance, with 175 points of resolution, ranging from conductive soil, such as saltwater beaches, to ferrous mineralized ground. During Ground Balance function, the words GND BAL appear on the display and the ground balance value is indicated on the LCD.

Ground Balance Procedure

Press and hold the GND BAL button while continually “bouncing” or “pumping” the searchcoil from 1 to 8 inches (2 to 20 cm) above the ground until there is a minimal audio response from the ground. Then release the button and begin hunting. The ground balance value will have been indicated on the LCD. A low ground balance value indicates conductive soil, such as saltwater beaches; high ground balance values indicate ferrous soil.

As the detector is being ground balanced, the ground balance value can be observed where the Digital Target ID number would normally display. Ground balance values from 0 to 75 are indicated with whole numerals. Ground balance values from 75 to 99 represent hot ground, and at this point the Apex utilizes High Resolution Ground Balance.

Beginning at 75, the ground balance value begins increasing in quarter-point steps. This is represented by a whole numeral and increasing quarter-steps of the upper bar graph. (See illustration showing GND BAL value of 92.75.)

Note: If the Ground Balance setting does not change during the auto ground balancing process, one of three issues likely exists: the detector is either sufficiently ground balanced already; the current ground exhibits such neutral mineralization that

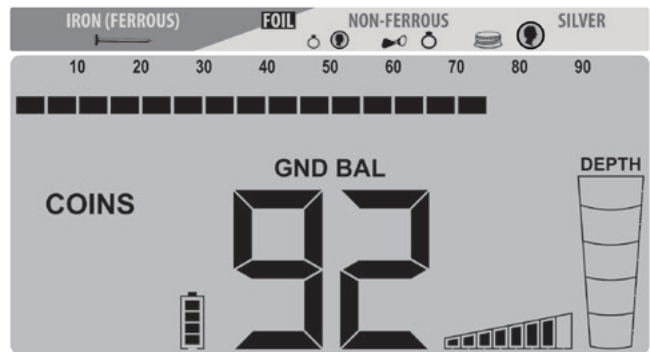

the settings will not change; or there is a metal object beneath the coil preventing the detector from ground balancing.

Typical Ground Balance Ranges:

- 80–99: Highly ferrous (magnetite, ferrous oxide minerals, black sands, hot rocks, terra cotta)
- 60–80: Moderately mineralized soils (red clay, brown clay, iron-bearing clay minerals, etc.)
- 20–60: Likely an iron object
- 0–20: Highly conductive, non-ferrous minerals such as saltwater

Iron Audio

Press and release the IRON AUDIO button to switch the Iron Audio feature ON/OFF.

Iron Audio allows the user to hear discriminated iron (normally silenced) in order to avoid being tricked into digging an undesired target. Iron Audio also adjusts the cut-off between low-tone and low-medium tone audio (see illustrations) to better identify good targets. When Iron Audio is on, iron targets will not only be heard, but they will produce an even more distinctive response with multiple tones. For example, a nail will produce several fast low tones as the searchcoil passes over. A flat iron object like a bottle cap or steel washer will produce a very distinctive Low-High-Low response.

Note: Iron Audio applies only to the notched out pixels to the left of the first accepted pixel within the 8-pixel iron range. Therefore, it is only effective when at least the first pixel of discrimination has been notched out.

Tip: In areas with heavy concentrations of iron, where Iron Audio produces numerous signals, it is recommended to reduce Iron Volume to a comfortable level. Some users may opt to switch off Iron Audio, switching it back on only when needed to check a detected target with questionable or inconsistent response to see if the target is iron.

Refer to the illustrations below regarding the use of the Iron Audio feature:

IRON AUDIO OFF:

Normal division of Apex's five audio tones.

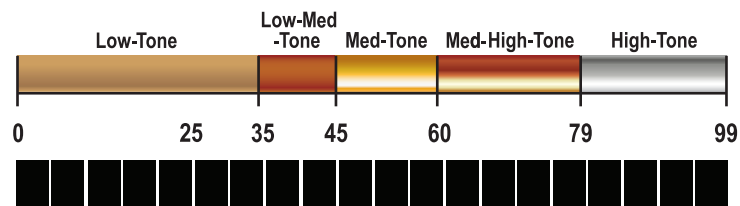

IRON AUDIO OFF:

With five pixels of Discrimination notched out, all targets below 25 are silent.

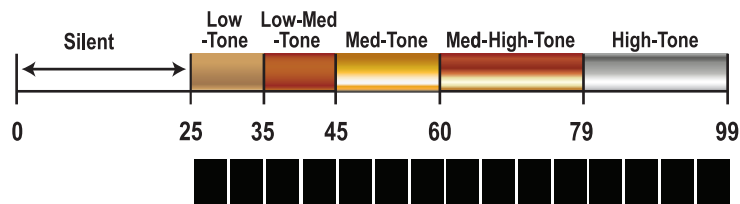

IRON AUDIO ON:

Targets below 25 are now heard as a low tone and targets from 25 to 44 will now produce Apex's low-medium tone. The normal tone breaks above 44 remain unchanged.

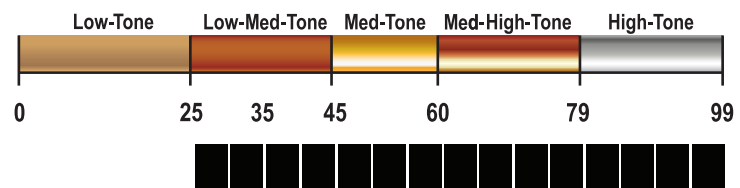

Detecting Techniques and Tips

If you are new to metal detecting, start searching in areas with sandy and loose soil to make it easier to learn how to use your metal detector, how to pinpoint a target, and how to recover it.

Adjust Detector Shaft and Coil Angle

Loosen Apex shaft camlocks and adjust the stem to an appropriate length. When your detector is properly adjusted, you should be able to swing the coil over the ground without stretching or stooping.

Your searchcoil should remain parallel to the ground as you sweep it. The coil's wingnut should not be overtightened. When properly tightened, the coil should remain in a parallel position when lifted from the soil, but loose enough so that the coil's angle can be easily adjusted for proper position.

Proper Coil Swinging

Keep your searchcoil height about 1 inch (2.5cm) above and parallel to the ground at all times for best detection results. Avoid excessive brushing of the coil against the ground.

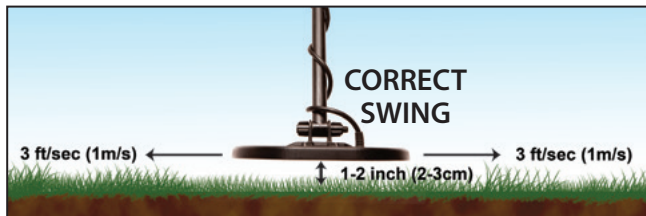

Swing your searchcoil parallel to plow lines and the water's edge. This will minimize the negative effects caused by uneven ground in plowed fields and varying amounts of moisture near the water. Do not swing the searchcoil perpendicular to plow lines and the water's edge, as this may produce abrupt changes in ground response that can reduce the detector's performance.

Walk slowly as you scan your searchcoil in a straight line from side to side at a speed of about 2 to 5 feet (1 meter) per second. Advance the searchcoil about half the length of the searchcoil at the end of each sweep.

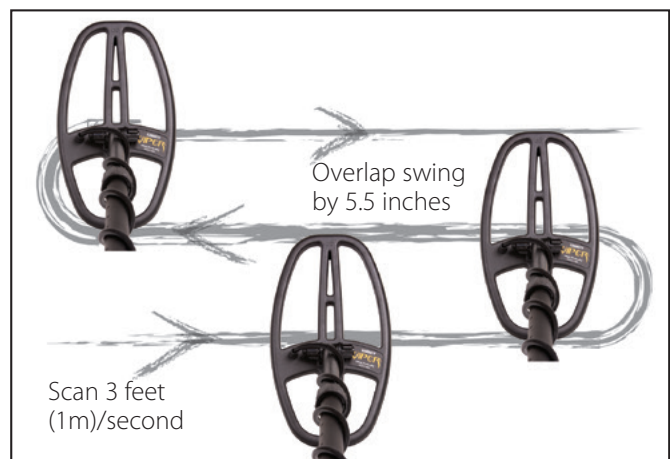

Electrical Interference and Ground Noise

Detector performance can be affected at times due to electromagnetic interference (EMI), which can create false signals or inaccurate Target ID. Examples of common EMI are electric fences, power lines, phone towers, and other detectors operating nearby.

To reduce or eliminate the effects of EMI, press the MENU button and scroll to CHANNEL. Use the (+) or (-) buttons to find a channel, or minor frequency shift, that results in more stable detector performance.

Ground noise, or ground interference, may be experienced in environments where high levels of ground mineralization are present (such as is often found in gold fields). To eliminate or reduce the effects of ground noise, you should ground balance your Apex (see Auto Ground Balance section for full details).

Detecting Techniques and Tips *(continued)*

Iron Masking Tip

To prevent an iron object from "masking" out the signal of an adjacent good target, use just enough discrimination to barely reject the iron trash (e.g. *small nail, as seen in Illustration 1*). This will allow you to detect the coin and nail together (see *Illustration 2*) and not miss/mask a good target.

Illustration 1

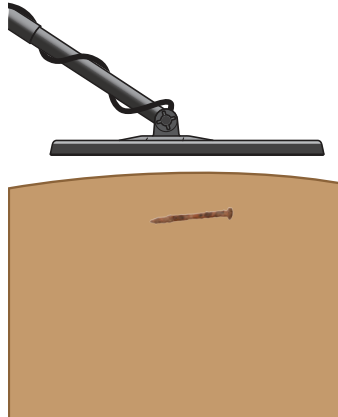

In this illustration, Apex is operating in Zero Mode with two pixels of iron eliminated. This nail registers from 18 to 24 on the Digital Target ID scale. To eliminate the nail from detection, notch three more pixels of iron.

Isolating Adjacent Targets

The narrow detection field of Apex's Viper DD searchcoil allows better separation of adjacent targets versus a similar size concentric searchcoil. Use narrow swings of the searchcoil in trashy areas to isolate good targets amongst the trash.

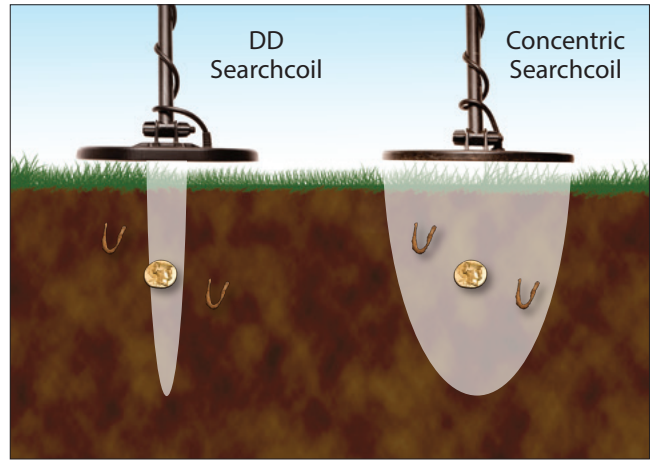

Illustration 2



In this illustration, the same iron nail is laying above a gold coin. With five pixels of iron now discriminated, the nail itself would not be detected; however, the two objects (nail and coin) have a combined conductivity of more than 25.

Therefore, the gold coin is detected due to the combined conductivity being higher than that of the discriminated target (nail) alone.



Pinpointing

Accurate pinpointing enables fast recovery with the smallest hole possible. To use Pinpoint:

- Position the searchcoil to the side of the target's suspected location at a fixed height above the ground.
- Press and hold the Pinpoint button and slowly sweep the searchcoil over the target area while maintaining the same fixed height above the ground (e.g. 1 inch).
- Sweep the searchcoil side-to-side and front-to-back in a cross-hair pattern to locate the peak signal, indicated by the loudest audio and the greatest number of segments on the Upper Scale.
- The center of the searchcoil is directly over the target with the depth of a coin-sized target shown on the depth scale. The symbol "PP" for pinpoint displays on the LCD while pinpointing.

It is recommended to practice pinpointing in a test plot.

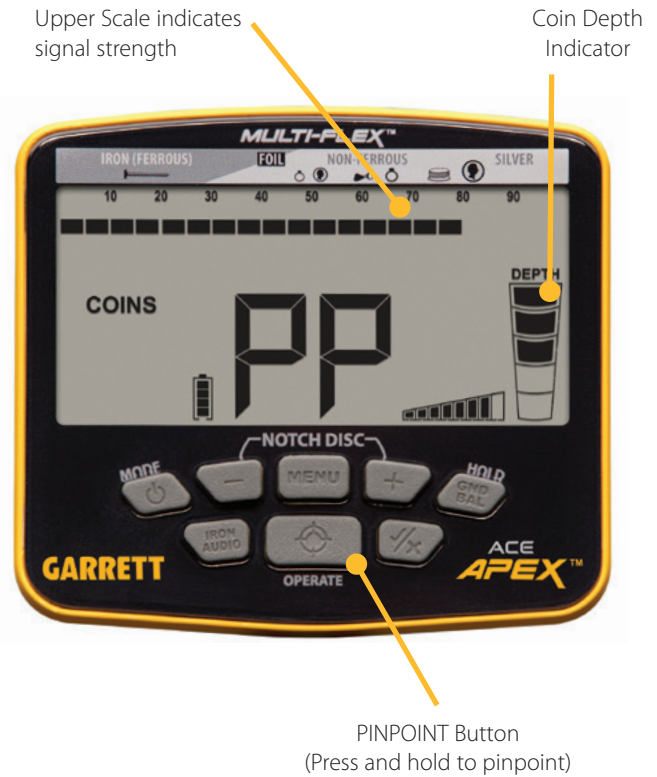

For the best pinpointing results, maintain a constant height above the ground (e.g. 1 inch).



⊕
Indicates pinpointing center of the 6" x 11" DD Viper searchcoil.

Note: Alternative pinpointing methods using a DD searchcoil are demonstrated on the *Apex* training video, which can be seen at garrett.com.

Bench Tests

You should conduct bench tests to become more familiar with your detector's operation. To conduct a bench test:

1. Place the searchcoil on a flat, non-metallic surface that is several feet from other metallic objects.
2. Select the ZERO Mode.
3. Pass various metal objects (coins, bottle caps, nails, etc.) across the searchcoil at a distance of 3 to 4 inches. Your metal detector will audibly and visually identify the target.
4. Perform this test in all the modes available on your detector. Observe the sounds as well as the graphics on the LCD that are made in each mode.
5. Record the results of your bench tests and refer to them when hunting in the field.

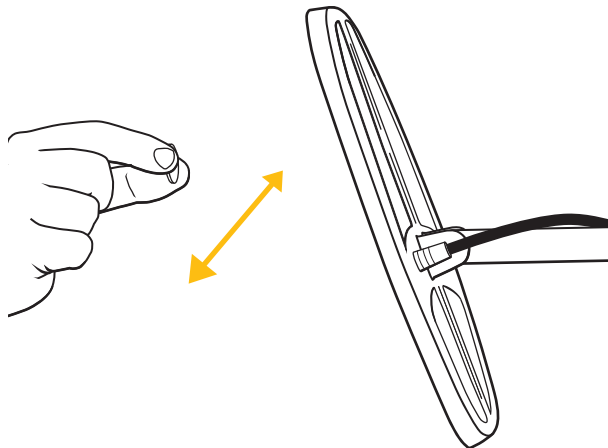

Once you have determined how your test targets register on the Target ID during bench tests, test them in the soil. Bury your targets at recorded depths to create a "test plot." Note how various targets read based upon whether they are lying in the ground flat or at various angles.

Keep accurate records or surface markers to indicate your test plot targets and their depths. Try testing these targets again in several months after the ground has

settled, during periods of extreme drought or after a soaking rain. Take note of any changes in how these targets are detected.

Iron Audio bench test

Flat iron objects like bottle caps or steel washers can appear to be good conductive targets. To better understand the benefits of Iron Audio, use a bottle cap to test *Apex*.

First, set the detector to ZERO Mode with all notches active and pass the bottle cap across the searchcoil at a distance of 3 to 4 inches. Note that the bottle cap's flat surface usually gives a high Digital Target ID reading with the tone of a "good" target.

Next, eliminate the first seven notches on the left side of the LCD, and switch on the Iron Audio feature. Pass the bottle cap across the coil again and notice the different audio. The clean sound has been replaced with a mixed, chirping tone that has subtle low tones at the beginning and end, indicating a possible junk target. Pass a conductive, coin-sized target across the coil and note its clean high tone in comparison to that of the bottle cap.

Record the results of your bench tests and refer to them when hunting in the field. Knowledge of the Iron Audio feature can reduce the amount of trash targets that are dug.

General Advice

Metal Detecting Code of Ethics

The following is a Code of Ethics that many treasure hunters and clubs follow to preserve our exciting sport of metal detecting. We encourage you to do the same:

- I will respect private and public property, all historical and archaeological sites and will do no metal detecting on these lands without proper permission.
- I will keep informed on and obey all local and national legislation relating to the discovery and reporting of found treasures.
- I will aid law enforcement officials whenever possible.
- I will cause no willful damage to property of any kind, including fences, signs and buildings.
- I will always fill the holes I dig.
- I will not destroy property, buildings or the remains of deserted structures.
- I will not leave litter or other discarded junk items lying around.
- I will carry all rubbish and dug targets with me when I leave each search area.
- I will observe the Golden Rule, using good outdoor manners and conducting myself at all times in a manner which will add to the stature and public image of all people engaged in the field of metal detection.

Cautions

When searching for treasure with your Garrett detector, observe these precautions:

- Never trespass or hunt on private property without permission.
- National and state parks / monuments and military zones, etc. are absolutely off-limits.
- Avoid areas where pipelines or electric lines may be buried. If found, do not disturb and notify proper authorities.
- Use reasonable caution in digging any target, particularly if you are uncertain of the conditions.
- If you are unsure about using your metal detector in any area, always seek permission from the proper authorities.

Caring for Your Apex

Your Garrett detector is rugged, designed for outdoor use. However, as with all electronic equipment, there are some simple ways you can care for your detector to maintain its high performance.

- Avoid extreme temperatures as much as possible, such as storing the detector in an automobile trunk during the summer or outdoors in sub-freezing weather.
- Keep your detector clean. Disassemble the stem and wipe it, the control housing, and the searchcoil with a damp cloth when necessary.
- Remember that your searchcoil is submersible, but your control housing and connectors are not.
- Recharge the detector's battery at least once a year if you are not using it regularly.

Troubleshooting

SYMPTOM	SOLUTION
No power	<ol style="list-style-type: none"> 1. Connect to charger and verify the battery icon is blinking (indicating charge is in progress). 2. Check charging cable and charger.
Erratic sounds or target ID cursor movement	<ol style="list-style-type: none"> 1. Ensure your searchcoil is securely connected and the coil cable is snugly wound around the stem. 2. If using the detector indoors, be aware that excessive amounts of electrical interference exists, plus excessive amounts of metal can be found in floors and walls. 3. Determine if you are close to other metal detectors or other metal structures such as electrical power lines, wire fences, benches, etc. 4. Adjust channel. 5. Reduce your sensitivity setting.
Intermittent Signals	<p>Intermittent signals typically mean you have found a deeply buried target or one that is positioned at a difficult angle for your detector to read. Scan from different directions to help define the signal or try selecting a different frequency to possibly enhance the target's response and scan again. In the case of multiple targets, switch to the ZERO Mode or press the pinpoint button to precisely locate all targets.</p> <p><i>NOTE: (Iron targets may cause Intermittent Signals. You can identify iron targets in ZERO Mode) or with the Iron Audio feature.</i></p>
I'm not finding specific targets	<p>Ensure you are using the correct mode for the type of hunting you are doing. If specifically hunting for coins, COINS mode should be your best choice to eliminate other undesirable targets. You may also use the ZERO mode, which detects all metal targets to ensure desired targets are present.</p>
Target ID Cursor bounces	<p>If your Target ID Cursor bounces erratically, chances are you've found a trash target. However, a Target ID Cursor may bounce if a good target (such as a coin) is not parallel to the searchcoil (e.g. on edge). It may also bounce if there is one or multiple "junk" targets laying next to the good target. Scan from different directions until your Target ID Cursor becomes more stable.</p> <p><i>NOTE: Large, flat pieces of iron—depending on their orientation in the ground—can read as a good target or can cause erratic Target ID Cursor movement. Use Iron Audio to help identify iron targets.</i></p>



ACE Apex Warranty Info

Your *Apex* detector is warranted for 24 months, limited parts and labor, but does not cover damage caused by alteration, modification, neglect, accident or misuse.

In the event you encounter problems with your *Apex* detector, please read through this Owner's Manual carefully to ensure the detector is not inoperable due to manual adjustments. Press and hold the power button for 5 seconds to return to the recommended factory settings.

You should also make certain you have:

1. Checked your battery charge and connections. A low battery is the most common cause of detector "failure."

2. Contacted your dealer for help, particularly if you are not familiar with the *Apex* detector.

In the event that repairs or warranty service are necessary for your *Apex*, contact the local retail outlet where your detector was purchased. To avoid excessive shipping and import charges, do not attempt to return a Garrett product to the factory in the United States.

Information on international warranty/repair needs can be found on the Garrett website: www.garrett.com. Click on the Sport Division and then the Warranty/Support menu for more details.

Regulatory Info

This device complies with part 15 of the FCC Rules. Operation is subject to the following two conditions: (1) This device may not cause harmful interference, and (2) this device must accept any interference received, including interference that may cause undesired operation.

Changes or modifications not expressly approved by the party responsible for compliance could void the user's authority to operate the equipment.

This device complies with Industry Canada license-exempt RSS standard(s). Operation is subject to the following two conditions: (1) this device may not cause interference, and (2) this device must accept any interference, including interference that may cause undesired operation of the device.

Ce produit est conforme aux normes RSS exemptes de licence d'Industry Canada. Son fonctionnement est soumis aux deux conditions suivantes : (1) ce dispositif ne peut pas provoquer d'interférences et (2) ce dispositif doit accepter toute interférence, y compris celles pouvant entraîner un dysfonctionnement.

Wireless Transmitter Specifications

Audio Delay:	17 milliseconds (6x faster than Bluetooth®)
Audio Bandwidth:	30-18,000 Hz
Operating Frequency:	2406-2474 MHz
Transmit Power:	8.6 dBm EIRP
Certifications:	FCC, CE, IC, AS/NZ

Technical Specifications

SPECIFICATIONS	
Multi-Flex™ Technology	✓
Single Frequency Options	5, 10, 15 and 20 kHz
Multi-Frequency Options	Simultaneous Multi-Freq. and Multi-Freq. Salt
Z-Lynk™ Wireless (integrated)	✓
Fast Target Separation/Recovery	✓
1/8" Headphone jack	✓
Backlight	✓
Ground Balance, Auto	High Resolution, 175 pts
Iron Audio™	✓
Iron Volume Control	✓
Iron Discrimination Segments	8
Volume Control	✓
Pinpointing	✓
Water/Weather Resistance	✓
• Waterproof coil/stem	✓
• Rainproof control box	✓
Search Modes	6, with International and US Coins modes
Large Digital Target ID	0 to 99 scale
Audio Tone ID Levels	5 tones included with hybrid binary and proportional audio system
Notch Discrimination	20 selectable segments
Sensitivity/ Depth Adjustments	8
Target Depth Indicator	2" / 5cm segments
Standard Searchcoil	6" x 11" DD Viper™
Length (Adjustable)	40" to 53" (1.016m - 1.35m)
Total Weight	2.5 lbs (1.13 kgs)
Battery Source	Rechargeable Lithium Ion, built-in; 7.5Wh, 30 g
Battery Condition Indicator	✓
Warranty	2 Years, Limited Parts/Labor

